

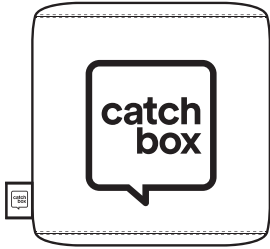

 **plus**
user manual

Copyright 2020 Catchbox SIA





Catchbox
Cover

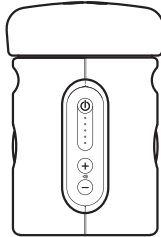

Catchbox Plus
Transmitter



Catchbox Plus
Receiver

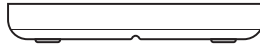

Catchbox Wireless
Charger

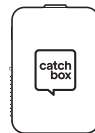

Catchbox
Presenter Mic

Contents

1 Safety Instructions	4
2 Quick Start	5
Setting Up the Catchbox.....	5
Throwing the Catchbox.....	12
Speaking into the Catchbox	13
3 Product Description	14
Overview.....	14
DECT Wireless Standard Overview	15
4 General System Specifications	16
Transmitter Specifications	17
Receiver Specifications.....	18
Wireless Charger Specifications.....	19
Presenter Mic Specifications	20
Catchbox Cover Specifications	21
5 Operations	23
Opening the Catchbox Microphone	23
Locking the Transmitter to the Cover	24
Setting up the Receiver.....	25
Setting up the Transmitter.....	29
Pairing the Transmitter and the Receiver	30
Charging the Transmitter with the USB cable	31
Charging the Transmitter with the Wireless Charger	32
Setting up the Presenter Mic.....	33
Pairing the Presenter Mic and the Receiver.....	35
Charging the Presenter Mic.....	36
How to wear the Presenter Mic.....	37
Setting the lanyard on the Presenter Mic.....	38
6 Troubleshooting	39
7 Maintenance, Storage, and Disposal	41
8 Certification	43

1 Safety Instructions

NOTICE

- Before using the product, read and understand the user manual and inform others of proper usage.
- Follow all warnings and instructions on the product and in this manual.
- Keep this user manual and always include it when passing the equipment on to third parties.

WARNING

- Not heeding these warnings may lead to serious injury or property damage.
- Do not throw at peoples' heads and always make sure everyone is aware of the situation before throwing.
- Do not use in situations with fragile objects, hot liquids, or people susceptible to injury, like the very young or old.
- Do not throw long passes (>5 m / 16 ft) or hard passes.
- Properly lock the into the Cover before use. Always use the Cover and the foam cap on the Transmitter, when using the product.
- Operating or storing this product at temperatures above 50 degrees Celsius or 122 degrees Fahrenheit will cause the locking mechanism to fail permanently.
- The use of other antennas than those provided by the manufacturer is strictly prohibited.
- This product contains magnets which could affect the functioning of pacemakers and other electronic implants. These could stop working or switch into test mode, causing illness. If you wear these devices keep sufficient distance to magnets. Warn others who wear these devices from getting too close to magnets.

CAUTION

- Magnets produce a far-reaching, strong magnetic field. Keep magnets away from devices and objects that could be damaged by strong magnetic fields, like laptops and other electrical equipment.
- Do not place the product near heat sources such as heating ducts or radiators and do not expose it to direct sunlight, excessive dust, moisture, rain, mechanical vibrations or shock.
- Do not use near water. Use equipment indoors only. If the equipment comes into contact with a liquid, turn off the product, shut down the sound system and disconnect the power cable from the power outlet immediately.
- Avoid excessive volume. Do not exceed 70dBa for airborne noise.
- Operate the equipment only with the included power supply.
- Clean the equipment with a moistened (not wet) cloth only. Be sure to disconnect the equipment from the power outlet before cleaning the equipment. Unplug the apparatus during lightning storms or when not in use.
- Protect the power supply cord from being walked on or pinched.
- The equipment should be opened, serviced, and repaired by qualified service personnel only.
- Do not attempt to modify this product or its accessories and use only accessories and attachments, like antennas and power supply, specified by the manufacturer.
- Changes or modifications to the equipment not expressly approved by manufacturer can void the warranty and user's authority to operate the equipment.
- Wireless Charger uses strong electromagnetic field to operate. Keep the the equipment away from metallic objects as those can heat up and cause injury or property damage.

2 Quick Start

Setting up the Catchbox

Step 1

Identify your Use Case

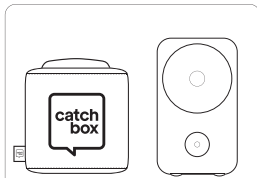

Use Case A
Catchbox with an Audio System

This diagram shows a Catchbox Plus Receiver unit on the left and a circular speaker on the right. The receiver has a speech bubble icon with the text 'catch box' and a small 'BT' logo on its side.



Use Case B
Catchbox with a Computer

This diagram shows a Catchbox Plus Receiver unit on the left and a laptop computer on the right. The receiver has a speech bubble icon with the text 'catch box' and a small 'BT' logo on its side.



Use Case C
Catchbox with an Audio System and a Computer

This diagram shows a Catchbox Plus Receiver unit on the left, a laptop computer in the middle, and a circular speaker on the right. The receiver has a speech bubble icon with the text 'catch box' and a small 'BT' logo on its side.



To reduce setup time, each Catchbox Plus Receiver and Catchbox Plus Transmitter unit have been paired before being shipped.

Use Case A

Catchbox with an Audio System

1. Plug the included Power supply to AC mains outlet and connect it to the Receiver's USB-C socket.
2. Plug the included audio cable to the Receiver's LINE OUT audio output and connect it to the input of your Audio System (mixer board, amplifier or other audio device).
3. Turn on both the Transmitter and the Receiver.

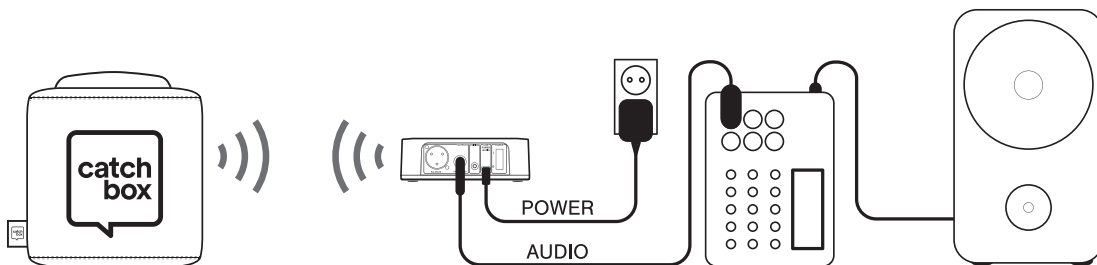

Depending on the input type of your Audio device, you may need to use additional audio adapters (purchased separately). Please refer to the wiring diagram of the Receiver's balanced audio output (page 18)

Use Case B

Catchbox with a Computer

1. Plug the included USB data cable to to the computer's USB port and connect it to the Receiver's USB-C socket.
2. Turn on both the Transmitter and the Receiver.
3. Go to your computer's audio settings and enable the input signal from Catchbox. See detailed instructions on Page 26.

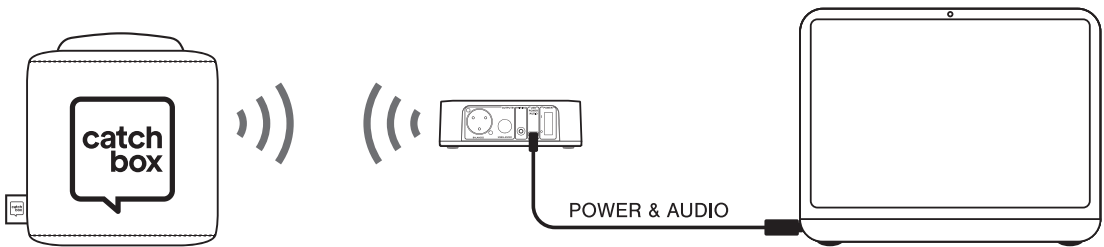

Use Case C

Catchbox with an Audio System and a Computer

1. Plug the included USB data cable to the computer's USB port and connect it to the Receiver's USB-C socket.
2. Plug the included audio cable to the Receiver's LINE OUT audio output and connect it to the input of your Audio System.
3. Turn on both the Transmitter and the Receiver.
4. Go to your computer's audio settings and enable the input signal from Catchbox. See detailed instructions on Page 26.

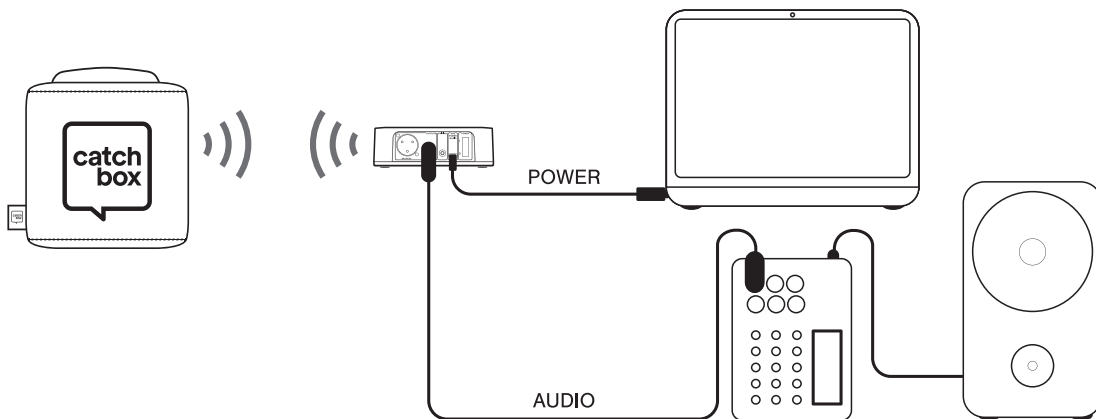

Depending on the input type of your Audio device, you may need to use additional audio adapters (purchased separately). Please refer to the wiring diagram of the Receiver's balanced audio output on (page 18).

Step 2

Remove the Transmitter from the Cover by twisting it 90 degrees and pulling upwards. This motion will misalign the internal magnets and allow for easy removal of the Transmitter unit.

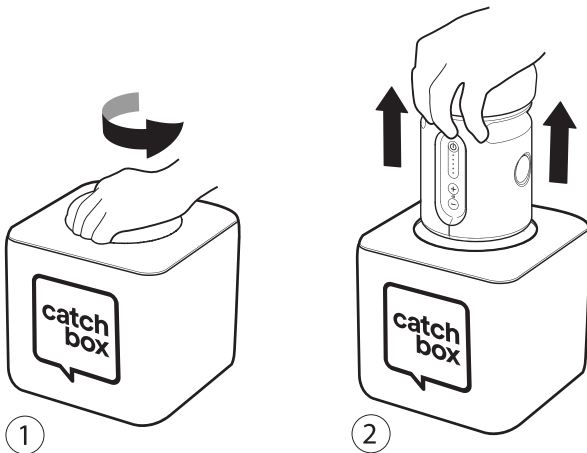

Step 3

To turn on the Transmitter press and hold the power button. LEDs on the front panel will turn on.

Connect the Receiver to the power source. Turn On the Receiver using the switch on the back panel of the device. The LEDs in the front panel will turn on.

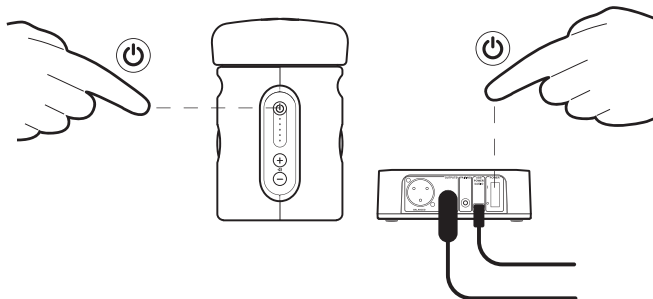

Step 4

Adjust the volume using the volume buttons on the Transmitter and on the Receiver.

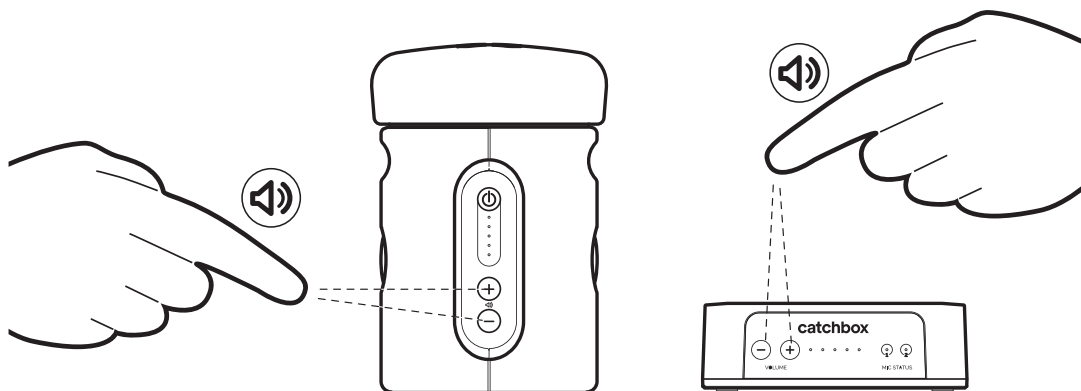

Avoid excessive volume. Do not exceed 70 dBa for airborne noise.

Step 5

Place the Transmitter into the Cover, making sure to align the magnetic locking mechanism so it is secure. Use the visual marks for guidance.

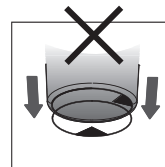
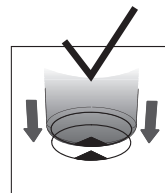
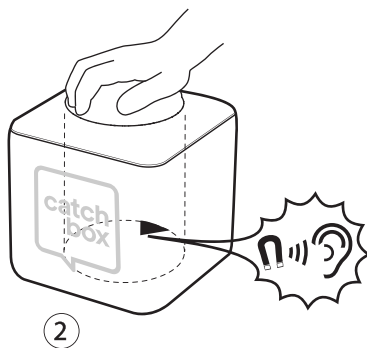
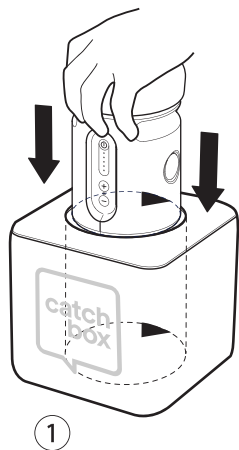

Always properly lock the Transmitter unit, with the attached foam cap, into the Cover before use. Improperly locking the Transmitter, or a failed locking mechanism, will result in the Transmitter unit coming out during use, potentially leading to serious injury and/or property damage.

Throwing the Catchbox

To throw the Catchbox microphone, find someone in the audience who wants to ask a question or make a comment. Make sure that the person and those around him or her are aware of the situation and are prepared to catch.

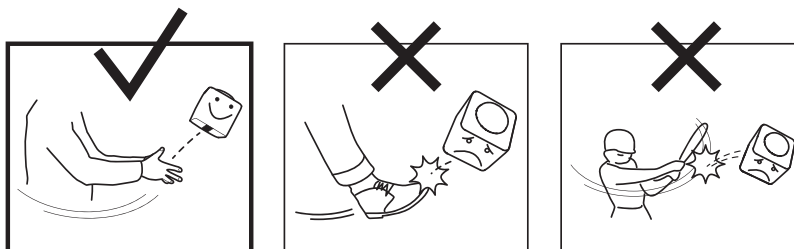

Short, underhand passes of up to 5 m / 16 ft distance are recommended.



If someone farther away has a question, try to get the entire audience involved by having members pass the Catchbox short distances to the person who wants it. This is a great way to activate the crowd.



Improper throwing and use of the device can lead to serious injury and/or property damage. Do not throw at peoples' heads and always make sure everyone is aware of the situation before throwing. Do not use in situations with fragile objects, liquids, or people susceptible to injury. Do not kick or hit the Catchbox.

Speaking into the Catchbox

To use the Catchbox, simply speak into the foam cap located on top of the Transmitter. An optimal distance of 20 cm / 8 in will provide the clearest sound while not blocking the face of the person speaking.

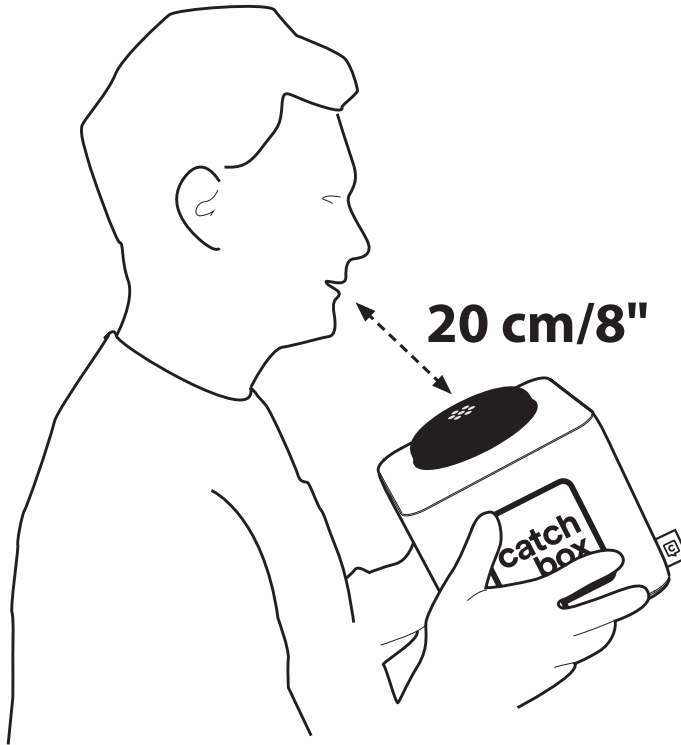

Avoid using the Catchbox near loudspeakers as this can cause audio feedback.

3 Product Description

Overview

Catchbox Plus is a complete wireless microphone system designed for use in meeting rooms and event spaces with audiences of up to 1000 people with the wireless range of up to 100 m / 330 ft (Line of Sight). The product includes a Receiver and one or two Transmitters (capsules) with soft Catchbox Covers. Wireless Charger and Presenter Mic are optionally available.

Transmitter capsule comes with a rechargeable Li-ion battery that can be recharged using the included power with USB-C connector supply or the Wireless Charger. Catchbox automatically turns off when placed onto the Wireless Charger and turns back on when picked up eliminating the need for active device management. The unique patented Automute technology turns off the audio signal when the microphone is being thrown ensuring the system doesn't make any unwanted noises when passed around (US Patent: US9936319B2).

Catchbox Plus uses DECT digital wireless communications standard (DECT 6.0 in North America, J-DECT in Japan). Two built-in antennas and Dynamic Channel Allocation (DCA) algorithm for frequency selection makes sure Catchbox Plus won't interfere with other wireless microphones or DECT-enabled devices.

Key Features

- Licence-free wireless transmission
- Rechargeable battery
- DCA automatic frequency selection
- Automute technology
- Wireless charging
- Two microphone connectivity
- USB audio output
- Balanced analog audio output

DECT Wireless Standard Overview

DECT is an acronym for Digital Enhanced Cordless Telecommunications. DECT standard uses a distributed Dynamic Channel Allocation (DCA) algorithm to automatically and dynamically (during the use of the product) select the transmission frequency from the designated frequency band. It helps to avoid potential interference with other DECT-enabled devices. However, other DECT-enabled devices such as cordless phones or translation systems may cause interference if used close to the Catchbox Plus system. The wireless range of Catchbox Plus product is 100 m / 330 ft under ideal working conditions (Line of Sight). However, indoor obstacles like walls, furniture and people may reduce the effective range.

DECT standard uses the following frequency bands:

1.880 to 1.900 GHz in Europe

1.920 to 1.930 GHz (DECT 6.0) in the United States and Canada

1.893 to 1.906 GHz (J-DECT) in Japan

Other regions in the world may use different spectrum allocations. Please check the actual frequency band with your local authority.

Improving wireless signal strength

Users can improve the performance of the system through the following measures:

Ensure that there are no objects or walls between the Transmitter and the Receiver

Decrease the distance between the Transmitter and the Receiver

Don't place the Transmitter and the Receiver in different rooms

Don't place the Receiver in a closed area, like inside a cupboard (especially metallic).

4 General System Specifications

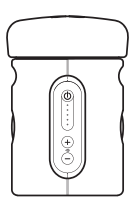

Catchbox Plus
Transmitter

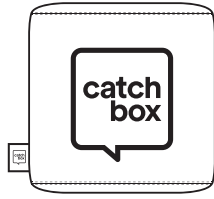

Catchbox
Cover



Catchbox Plus
Receiver



Catchbox
Wireless Charger

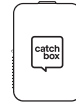

Catchbox
Presenter Mic

Included components:

- Catchbox Plus Transmitter (one or two)
- Catchbox Cover (one or two)
- Catchbox Plus Receiver with power supply
- Audio cable
- USB-C audio data cable
- Catchbox Wireless Charger with power supply (optional)
- Catchbox Presenter Mic with power supply (optional)

Specifications

Working range	30 m / 100 ft (Line of Sight)*
Transmitters per receiver	2
Frequency band	DECT / DECT 6.0 (1.8 / 1.9 GHz band)
Max radio output power	100 to 200 mW
Signal type	Digital

Antenna diversity	Yes
Max # of transmitters in one space	EU: up to 8, US: up to 4 Please see our website for other regions
Audio latency	One transmitter: 14 ms Two transmitters: 18ms
Operating temperature range	0 °C (32 °F) to 30 °C (86 °F)
Storage temperature range	0 °C (32 °F) to 50 °C (122 °F)

Transmitter Specifications

Parts

1. Foam Cap
2. Power button
3. LEDs
4. Volume up button
5. Volume down button
6. Magnetic lock
7. Power jack (USB-C)

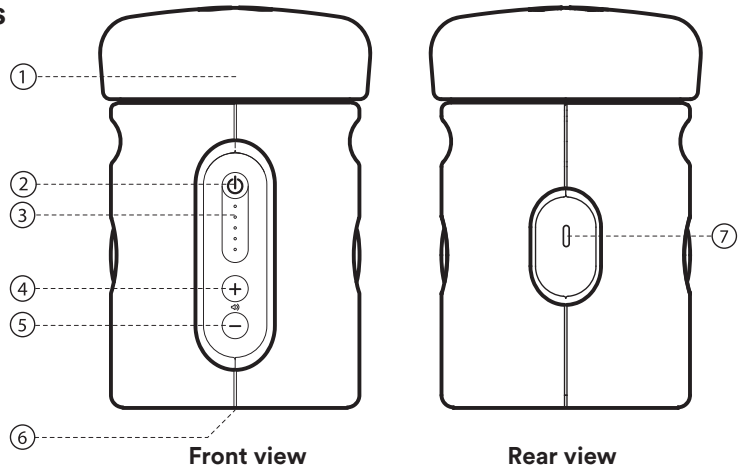

Specifications

Weight	370 g / 13.05 oz	Gain offset range (Volume control)	8 dB in steps of 2 dB
Dimensions	180 x 180 x 180 mm / 7 x 7 x 7 in	Battery type	Li-ion, rechargeable
Built-in Automute technology	Yes	Battery life	12h
Microphone element	Electret condenser, omni-directional	Battery charge time	Wireless: 6h USB-C: 3h
Audio frequency response	50 to 11000 Hz	Wireless charger compatible	Yes (Catchbox proprietary protocol)

Audio frequency response

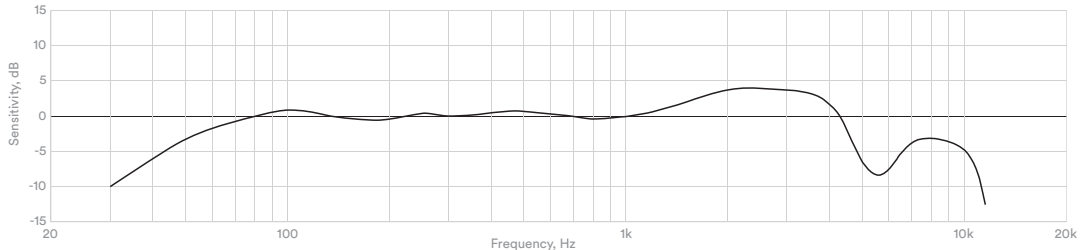

Note: Frequency response is measured with attached foam cap

Receiver Specifications

Parts

1. Volume buttons
2. Volume LEDs
3. Status LEDs
4. Pairing button
5. Line level audio output
6. Mic level audio output
7. Power switch
8. Power jack (USB-C)

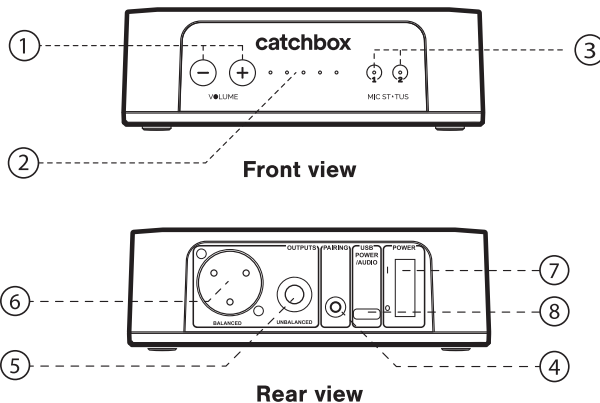

Specifications

Weight	200g / 7oz
Dimensions (without antennas)	130 x 130 x 40 mm / 5.1 x 5.1 x 1.4 in
Power supply	5V 1A USB-C
Audio outputs	T6.3 mm / 1/4 in jack socket - unbalanced, Line level XLR - balanced, Mic level USB-C - digital output
Gain offset range (Volume control)	30 dB in steps of 3 dB (separate Mute setting)

Balanced XLR Audio output



- PIN 1 - GND
- PIN 2 - AUDIO +
- PIN 3 - AUDIO -

Unbalanced stereo 1/4" (6,35mm) TRS Audio output

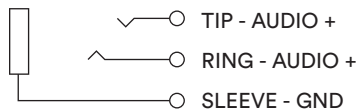

Wireless Charger Specifications

Parts

1. Indication LEDs
2. Power jack (USB-C)

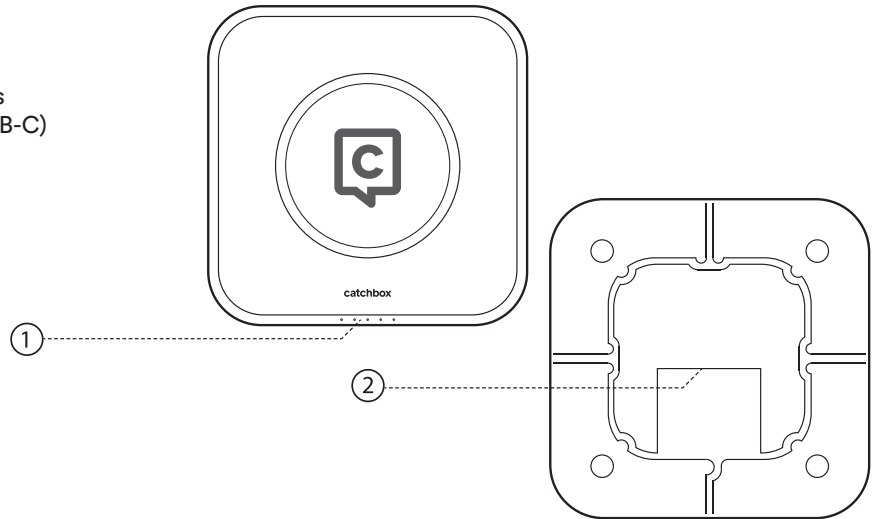

Specifications

Weight	385 g / 13.6 oz
Dimensions	189 x 189 x 30 mm / 7.44 x 7.44 x 1.18 in
Power supply	5V 1A USB-C
Charging protocol	Catchbox proprietary



Wireless Charger is optimized for charging only Catchbox products and will not charge other electronic devices such as mobile phones. Don't place electronic devices with the Wireless Charger as doing so may damage the Wireless Charger and/or device placed on it.

Presenter Mic Specifications

Parts

1. Microphone
2. Power button
3. LED
4. Volume up button
5. Volume down button
6. Power jack (USB-C)
7. Mic input (3.5 mm jack socket)

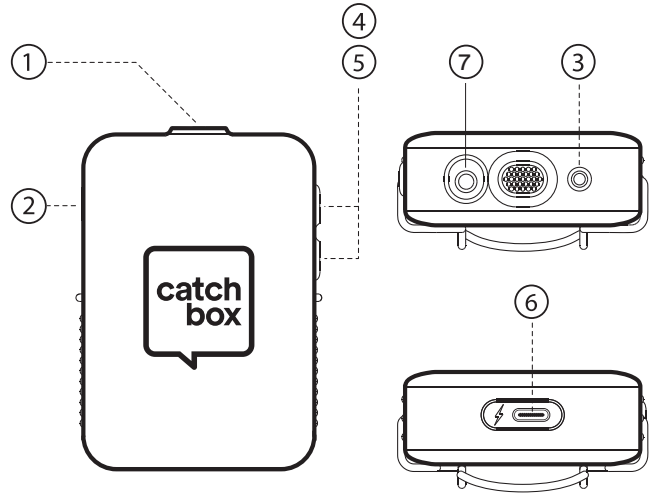

Specification

Weight (with clip) 80 g / 2.8 oz

Dimensions (with clip) 82 x 60 x 28 mm
/ 3.2 x 2.4 x 1.1 in

Audio frequency response
(built-in microphone) 50 to 11000 Hz

Microphone
connector 3.5 mm
/ 1/8 in jack socket

Battery type Li-ion, rechargeable

Battery life 7h

Battery charge
time USB-C: 2h

Wireless charger
compatible No

Catchbox Cover Specifications

Parts

1. Opening for transmitter unit
2. Magnetic lock

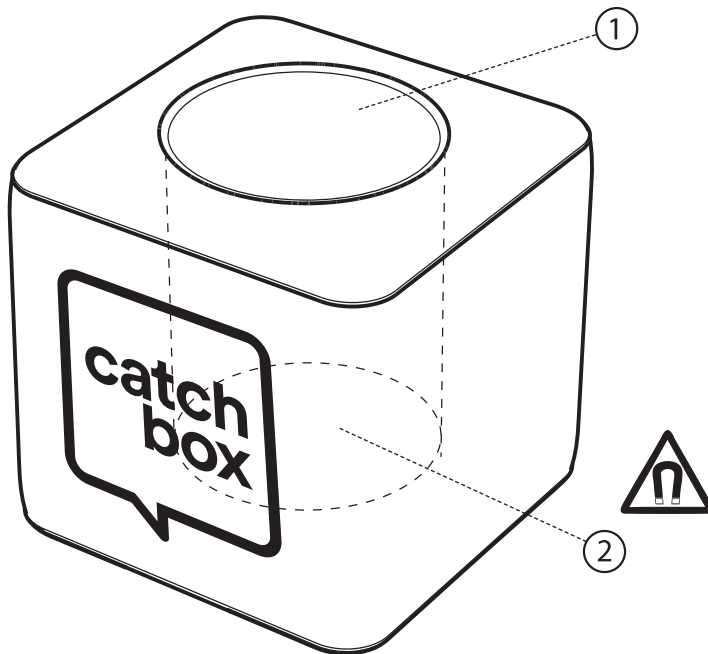

Specifications

Weight

200 g / 7 oz

Dimensions

18 x 18 x 18 cm / 7 x 7 x 7 in

Catchbox Plus Microphone Unit

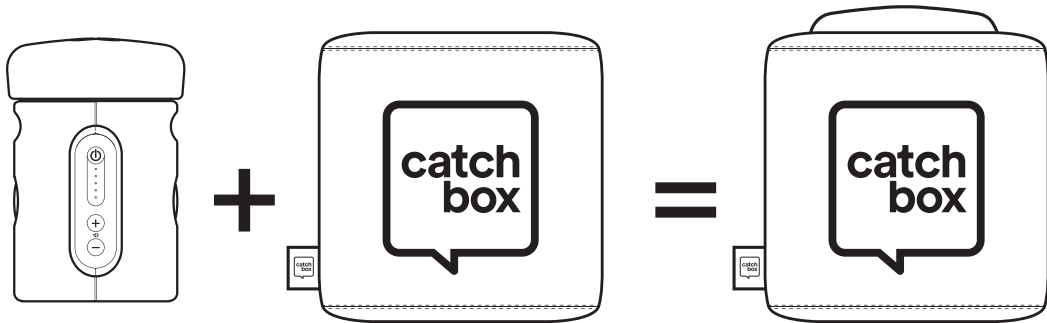

Specifications

Weight

365 g / 12.8 oz

Dimensions

18 x 18 x 18 cm / 7 x 7 x 7 in

5 Operations

Opening the Catchbox Microphone

The locking mechanism is composed of two magnets that attract each other when correctly aligned. Remove the Transmitter from the outer Cover by twisting it 90 degrees and pulling upwards. This motion will misalign the internal magnets and allow for easy removal of the Transmitter unit.

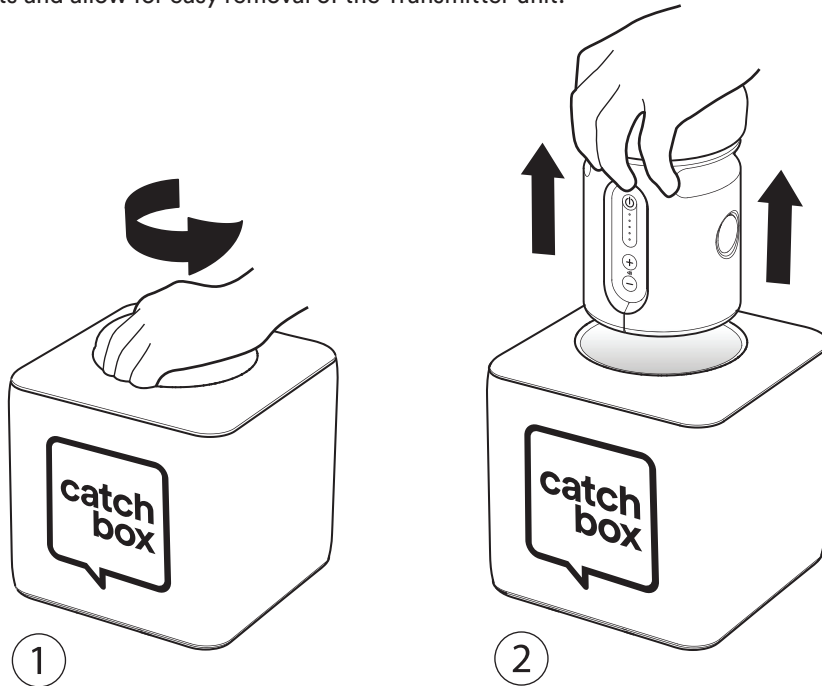

Locking the Transmitter to the Cover

The locking mechanism is composed of two magnets that attract each other when correctly aligned. To lock the Transmitter unit into the Cover align the marks located at the bottom of the Transmitter and bottom of the Cover with each other. Slide the Transmitter gently inside the opening of the Cover until you hear a click. Test whether the locking has been successful by pulling on the Transmitter and trying to remove it with a vertical force. If it does not come out with significant force, the magnets are correctly aligned.

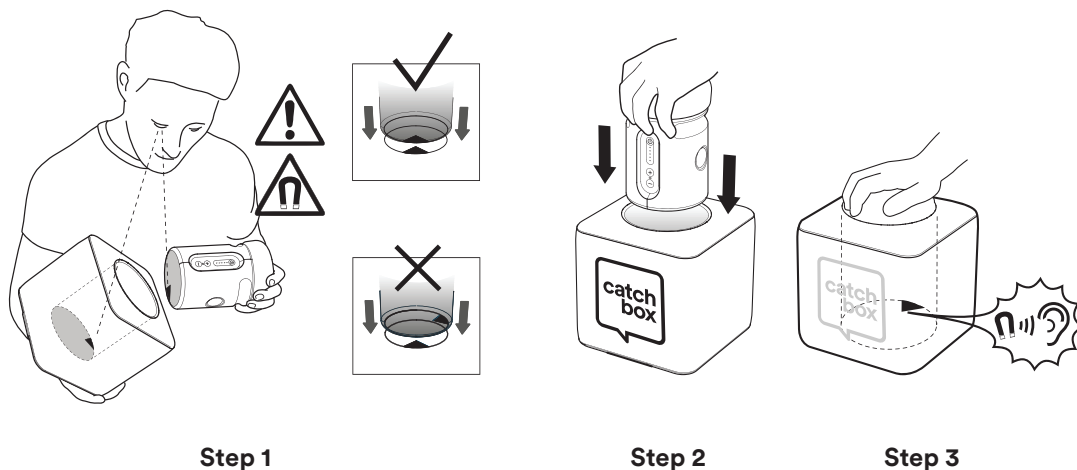

Always properly lock the Transmitter unit, with the attached foam cap, into the Cover before use. Improperly locking the Transmitter, or a failed locking mechanism, will result in the Transmitter unit coming out during use, potentially leading to serious injury and/or property damage.

Setting up the Receiver

Turning on the Receiver

Depending on your setup the Receiver will be powered by the included Power supply or by the computer's USB port. Please refer to Quick Start guide to choose the most suitable use case for your application.

1. Make sure that Receiver is properly powered.
2. Turn on the Receiver by flipping the switch on the back panel of the device.
3. LEDs on the front panel will light up indicating the device is on.

Adjusting the volume

1. Press the «+» or «-» buttons located on the front panel of the device.
2. Green LEDs will indicate the volume level.
3. Red LED will indicate MUTE state for the audio.

Using the line out audio output

Plug the included audio cable to the Receiver's LINE OUT audio output and connect it to the input of your audio device.

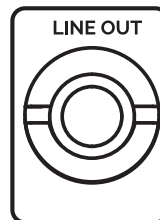
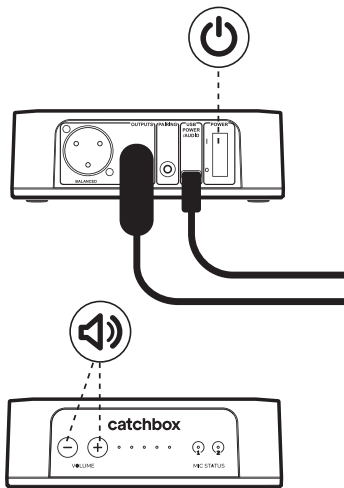

NB! Depending on the input type of your Audio device, you may need to use additional audio adapters (purchased separately). Please refer to the wiring diagram of the Receiver's balanced audio output (page 18).



Use only the included Power supply to power the Receiver. Using other manufacturers' equipment may cause malfunction and/or damage the Receiver.

Using the MIC OUT audio output

For balanced audio output, use the MIC LEVEL XLR connector. XLR cable not provided in the package.

Using the USB digital audio output

1. Plug the included USB data cable to to the computer's USB port and connect it to the Receiver's USB-C socket. The connection will provide both power and audio communication.
2. Go to your computer's audio settings and enable the input signal from Catchbox.

On Chrome devices

1. Go to Settings -> Audio settings
2. Change the Input to "Catchbox USB audio device"

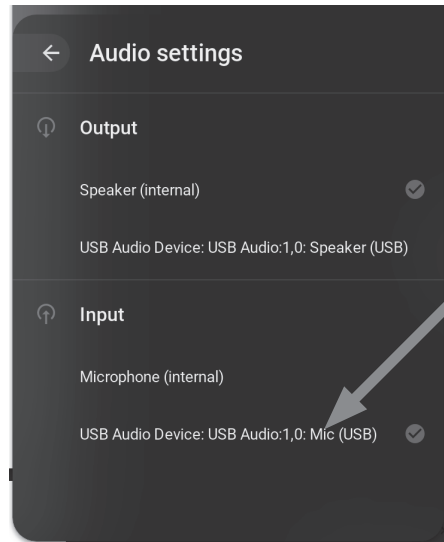
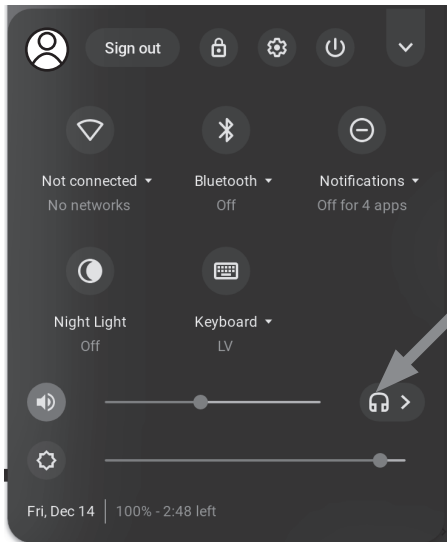
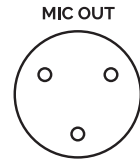

On Mac

1. Go to System Preferences -> Sound -> Output
2. Select "Catchbox USB audio device"

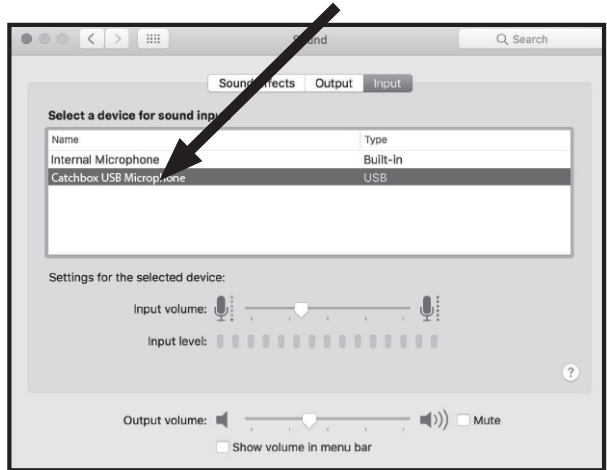

On Windows

1. Go to Control Panel -> Sound -> Recording
2. Select "Catchbox USB audio device"

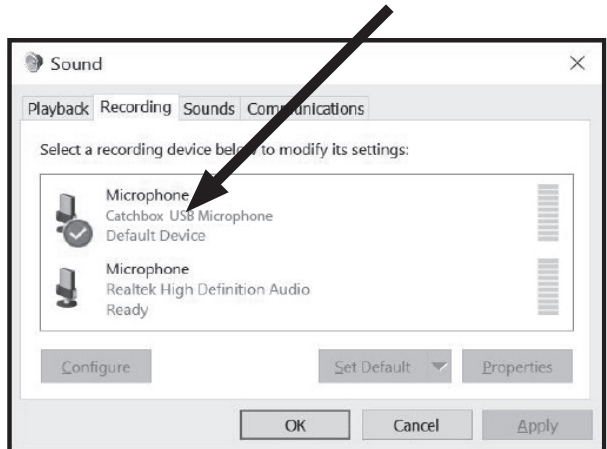

Setting up the Transmitter

Turning on the Transmitter

1. Press and hold the power button on the front panel of the device.
2. Green LED will light up indicating that device is powered. If LED is slowly blinking, it indicates that the Receiver is turned off.

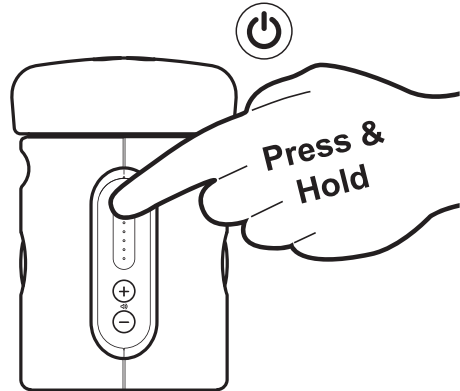

Adjusting the volume

1. Press the «+» or «-» buttons located on the front panel of the device.
2. LEDs will briefly light up indicating the volume level.

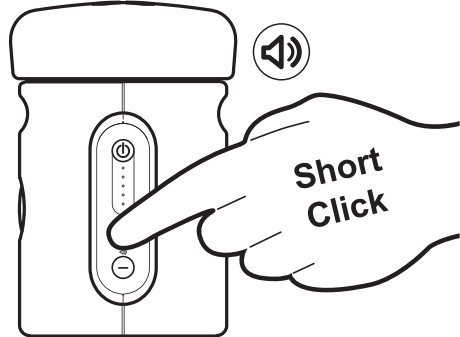

If the battery is critically low the Transmitter will not turn on and an LED will blink rapidly. In this case the battery can only be charged with the AC Power adapter

Checking the battery level

1. When Transmitter is turned on press the power button on the front panel of the device.
2. LEDs will briefly light up indicating the battery charge level.

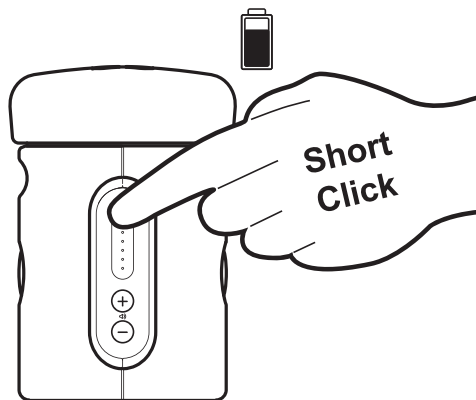

Hardware reset

1. Press and hold the power button for approx. 10s.
2. Green LED will light up indicating that device is powered.

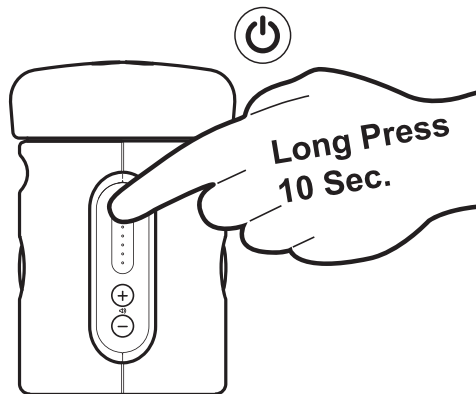

Pairing the Transmitter and the Receiver

Catchbox Plus Receiver can be paired with up to two Transmitters simultaneously. To reduce the setup time each Transmitter and Receiver unit have been paired in the factory before shipping.

The power-saving function for the transmitter reduces power consumption by switching off the radio connection between transmitter and receiver if the Catchbox has not been in motion for 2 hours. When in power-saving mode, the Catchbox remains on but consumes less power. Moving the Catchbox will restore the radio connection between the transmitter and receiver.

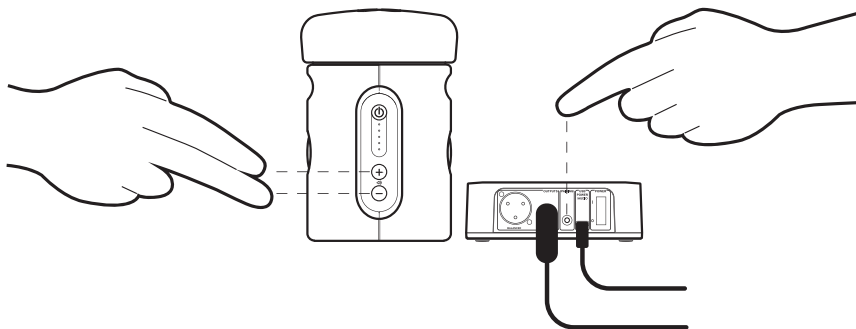

Pairing two devices

1. Make sure that both devices are turned on and located within 3m / 10 ft distance from each other.
2. On the Transmitter simultaneously press and hold both volume <<+>> and <<->> buttons.
3. LEDs on the Transmitter will display a sequence indicating that it is in Pairing mode and looking for a Receiver.
4. While Transmitter is in the Pairing mode press Pairing button on the Receiver.
5. Wait until connection is established.
6. Once devices are paired the LEDs on both devices will light up steadily and the audio signal will be passed from the Transmitter to the Receiver.

Unpairing the devices

1. Press and hold the Pairing button on the Receiver until Mic Status LEDs start blinking.
2. Wait for the pairing information to be cleared from all devices. Both Mic Status LEDs on the Receiver will turn off. All Transmitters will be disconnected from the Receiver.

Charging the Transmitter with USB cable

1. Plug the included Power supply to AC mains outlet and connect it to the USB-C socket located on the rear of the Transmitter.
2. LEDs on the front of the Transmitter will light up indicating the state of charge of the battery. Blinking will indicate the charging process is ongoing.
3. When all LEDs are steadily lit the battery is fully charged.

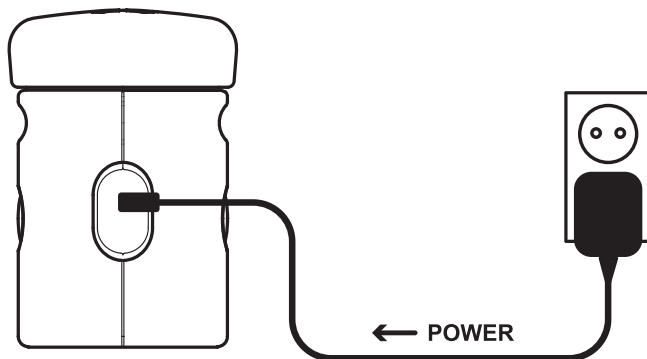

Note: Don't use for charging the included USB data cable with a computer as it may provide insufficient amount of power and will result in a long charging time.



Always use the included Power supply to charge the Transmitter. Other devices may provide insufficient amount of power which will result in long charging time.

Charging the Transmitter with the Wireless Charger

1. Plug the included Power supply to AC mains outlet and connect it to the USB-C socket on the Wireless Charger. Green LED on the Wireless Charger will turn on indicating that device is powered.
2. Place the Transmitter (securely attached inside the Cover) in its natural position to start the charging. Always ensure there are no foreign objects located between the Catchbox and the surface of the Wireless Charger.

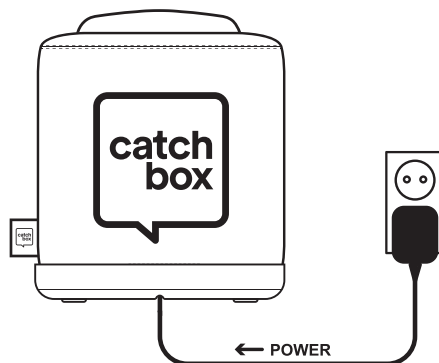

If all LEDs are blinking it indicates an error. Please see section Troubleshooting (page 39)



Always use the included Power supply to power the Wireless Charger. Other devices may provide insufficient amount of power which will result in long charging time.



Wireless Charger emits strong electromagnetic field which could affect the functioning of pacemakers and other electronic implants. These could stop working or switch into test mode, causing illness. If you wear these devices keep sufficient distance to device and warn others who wear these devices from getting too close to the device.

Setting up the Presenter Mic

Turning on the Presenter Mic

1. Press and hold the power button on the side of the device.
2. LED will light up indicating that device is powered. For LED indications, see next page.

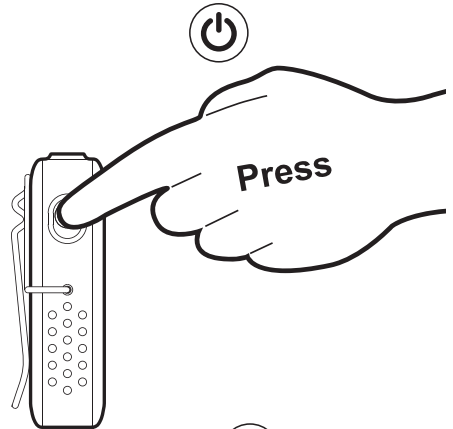

Adjusting the volume and muting the audio

1. Press the «+» or «-» buttons located on the side of the device.
2. To mute and unmute the Presenter Mic, fast click the power button on the side of the device.

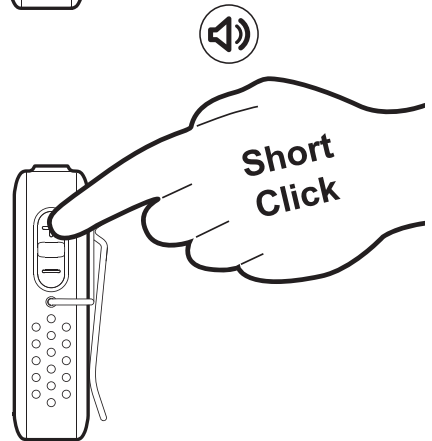

If the battery is critically low the Presenter Mic will not turn on and the LED will blink red a few times.

Hardware reset

1. Press and hold the power button for approximately 10 s.
2. Green LED will light up indicating that device is powered.

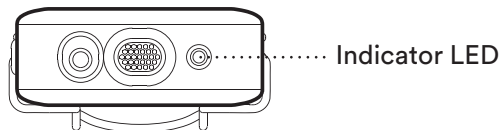
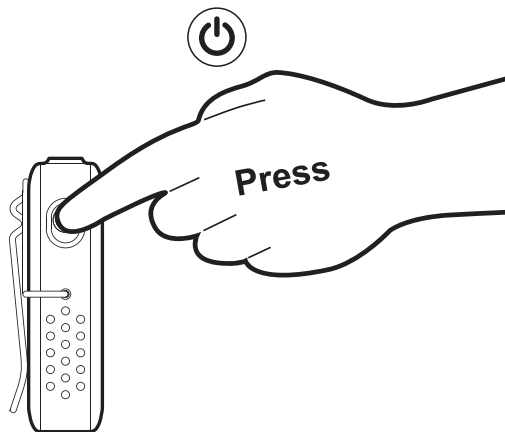

Status LED Indications

Off	○○○	Not powered
Green blinking	●●○○●●○○	Not yet paired to a receiver
Green & red blinking rapidly	●●●●	In pairing mode
Green	●●●	Power on, paired to a Receiver
Red	●●●	Low on battery (less then 2h operating time left)
Green pulsating	~~~~~	Charging
Green blinking	●○○●○○	On mute

Pairing the Presenter Mic and the Receiver

Catchbox Plus Receiver can be paired with up to two Transmitters simultaneously. To reduce the setup time each Transmitter and Receiver unit have been paired in the factory before shipping.

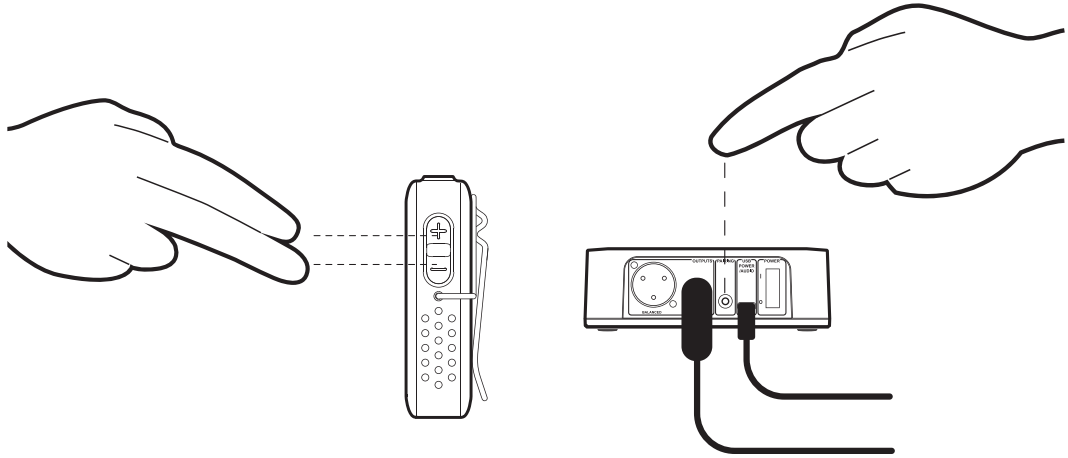

Pairing two devices

1. Make sure that both devices are turned on and located within 3 m / 10 ft distance from each other.
2. On the Presenter Mic simultaneously press and hold both volume <<+>> and <<->> buttons.
3. LED on the Presenter Mic will display a sequence indicating that it is in Pairing mode and looking for a Receiver.
4. While Presenter Mic is in the Pairing mode press Pairing button on the Receiver.
5. Wait until connection is established.
6. Once devices are paired the LEDs on both devices will light up steadily and the audio signal will be passed from the Presenter Mic to the Receiver.

Unpairing the devices

1. Press and hold the Pairing button on the Receiver until Mic Status LEDs start blinking.
2. Wait for the pairing information to be cleared from all devices. Both Mic Status LEDs on the Receiver will turn off. All Transmitters will be disconnected from the Receiver.

Charging the Presenter Mic

1. Plug the included Power supply to AC mains outlet and connect it to the USB-C socket located on the bottom of the Presenter Mic.
2. To indicate that the Presenter Mic is charging, the LED on the top of the device will pulsate green.
3. When LED is steadily lit green the battery is fully charged

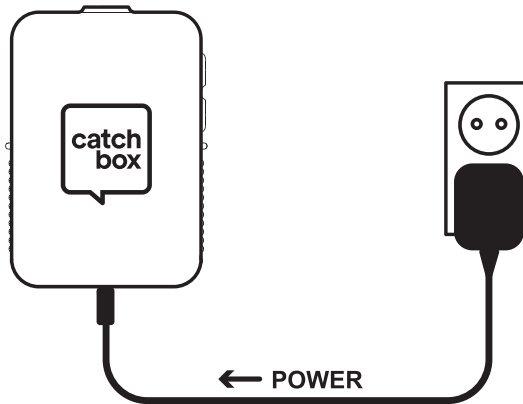

Always use the included Power supply to charge the Presenter Mic. Other devices may provide insufficient amount of power which will result in long charging time.

How to wear the Presenter Mic

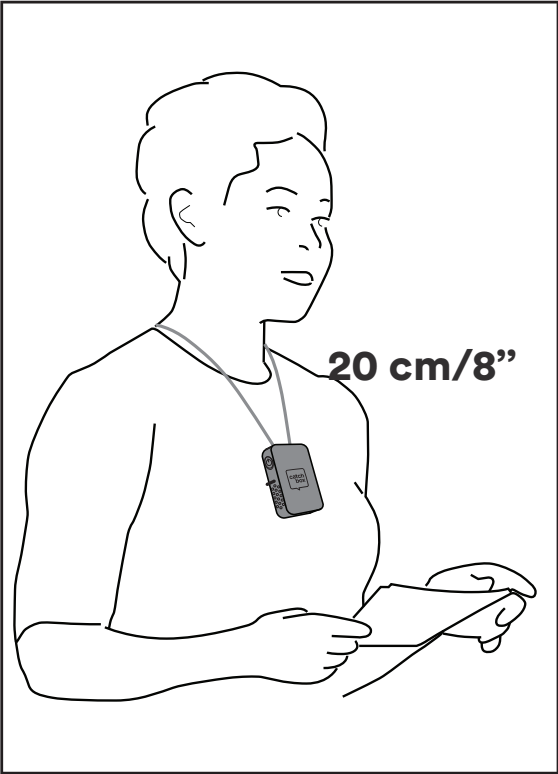

Wear it around your neck using the lanyard.

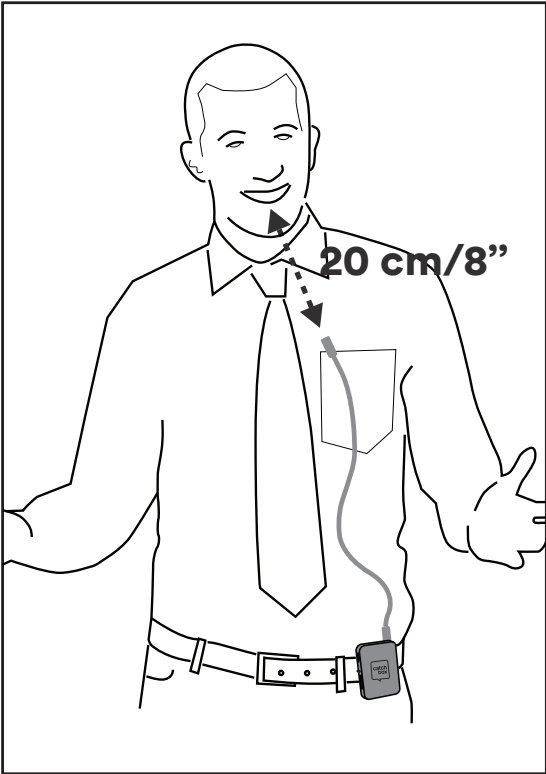

Wear it attached to clothing (e.g. belt or pocket).

Setting the lanyard on the Presenter Mic

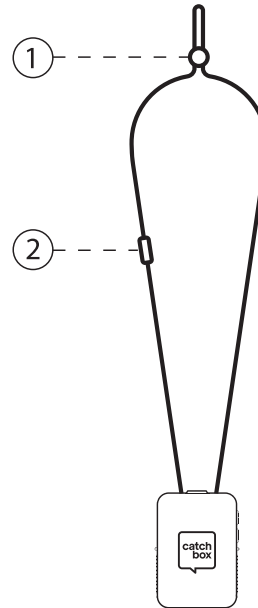
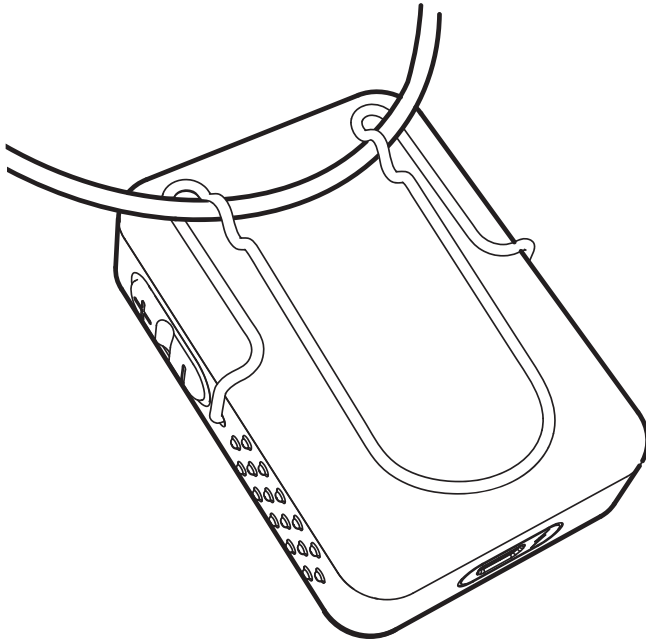

1. Length adjustment
2. Safety breakaway



Use only the included Lanyard with the Presenter Mic. Make sure the safety breakaway point is on the side of the lanyard or on the back of the neck of the user, so it can function properly.

6 Troubleshooting

Problem	Possible Cause	Solution
No sound	<ol style="list-style-type: none"> 1. The Transmitter and the Receiver are not paired. 2. The Transmitter or the Receiver is not powered. 3. Volume on the Receiver is on mute indicated by red light on the volume LEDs. 	<ol style="list-style-type: none"> 1. Pair the Transmitter and the Receiver units. See how to pair devices in Operations section. 2. Turn on the Transmitter. Plug the Receiver into a wall socket and turn on. 3. Increase the volume level on the Receiver.
Audio signal dropouts or breaks	<ol style="list-style-type: none"> 1. The Transmitter and the Receiver are located too far from each other. 2. There are obstacles in between the Transmitter and the Receiver 	<ol style="list-style-type: none"> 1. Place the Transmitter and the Receiver closer to increase signal strength. 2. Place the Receiver unit in clear view of the Transmitter.
Distorted sound	<ol style="list-style-type: none"> 1. Audio cable or adapter piece is broken or not properly attached. 2. Volume level is too high. 	<ol style="list-style-type: none"> 1. Check the audio cable connection and adapter piece. If problem persists, replace the cable and/or adapter. 2. Decrease the volume on the Transmitter or the Receiver.
Audio feedback	<ol style="list-style-type: none"> 1. Catchbox microphone is situated too close to the loudspeakers. 2. Volume level is too high. 	<ol style="list-style-type: none"> 1. Move Catchbox microphone away from the loudspeakers. 2. Decrease the volume on the Transmitter or the Receiver.
Transmitter does not turn on	<ol style="list-style-type: none"> 1. Battery level is critically low indicated by rapidly blinking LED 	<ol style="list-style-type: none"> 1. Charge the Transmitter using the AC Power adapter.
Transmitter is not charging with the AC power adapter	<ol style="list-style-type: none"> 1. AC Power adapter does not provide enough power. 2. Power cable is broken or not properly attached. 	<ol style="list-style-type: none"> 1. Use the included AC Power adapter. 2. Check the cable connection. If the problem persists replace the AC Power adapter.

Problem	Possible Cause	Solution
Wireless Charger is not working	<ol style="list-style-type: none"> 1. Wireless Charger is not powered. 2. Battery level of the Transmitter's battery is critically low. 	<ol style="list-style-type: none"> 1. Attach the power cable to the Wireless Charger. 2. Charge the Transmitter with the AC Power adapter.
Wireless Charger all LEDs are blinking	<ol style="list-style-type: none"> 1. There is a foreign object between the Transmitter and the Wireless Charger. 2. Catchbox is not properly placed on the Wireless Charger. 3. The Transmitter is placed on the Wireless Charger without a Cover. 4. Transmitter has been heating up. 5. AC Power adapter does not provide enough power. 	<ol style="list-style-type: none"> 1. Remove the foreign object and place Catchbox on the Wireless Charger. 2. Place Catchbox at the center of the Wireless Charger. 3. Place the Transmitter in Cover and place Catchbox on the Wireless Charger. 4. Remove the Transmitter from the Cover and let it cool down. Check the ambient temperature in the room not to be above 30 degrees Celsius 5. Use the included AC Power adapter



For more technical assistance

- contact us by email info@catchbox.com
- chat on our website www.catchbox.com
- visit our Youtube channel

7 Maintenance, Storage, and Disposal

Proper maintenance and storage of the Catchbox Plus wireless system will help ensure the product remains operational and safe to use. Improper maintenance or storage, in turn, can lead to equipment failure which can cause serious injury during use. Always refer to this user manual for proper maintenance, storage, and disposal instructions and do not throw away this user manual. Always keep it near the product for reference by other users.

Cleaning

- Clean the equipment with a moistened (not wet) cloth only. Be sure to disconnect the equipment from the power outlet before cleaning.
- To clean the outer Cover, first remove the Transmitter unit from the inside. Only use dry cleaners and do not place the outer Cover in a washing machine. Always remember to inform cleaners that the device contains a magnet and should not be treated in temperatures in excess of 50 degrees Celsius or 122 degrees Fahrenheit or near equipment sensitive to strong magnetic fields

Storage

- Magnets produce a far-reaching, strong magnetic field. Keep magnets away from devices and objects that could be damaged by strong magnetic fields, like laptops and other electrical equipment.
- Always store the product in temperatures between 0 to 50 degrees Celsius (32 to 122 degrees Fahrenheit)
- Exposing this product to temperatures above 50 degrees Celsius or 122 degrees Fahrenheit will cause the locking mechanism to fail permanently. This, in turn, will cause the Transmitter capsule to fall out of the Cover during use, potentially leading to personal injury or property damage.
- Do not place the equipment near heat sources such as heating ducts or radiators and do not expose it to direct sunlight, excessive dust, moisture, rain, mechanical vibrations, or shock.
- Do not use or store near water. If the equipment comes into contact with a liquid, disconnect the power cable from the power outlet immediately.

Disposal

- To dispose of a broken or defective unit, send the unit back to the manufacturer or consult your local waste management professional.

Maintenance of the lithium-ion battery

This product contains rechargeable lithium-ion battery. Please follow these guidelines:

- Do not open or modify the product to access or replace the battery.
- Do not damage or pierce the battery. It may lead to accumulation of hazardous gases and cause explosion or fire leading to injury and property damage.
- Always carefully follow the instructions for charging the battery.
- Do not expose the product to water or fire.
- Always use the product in temperatures between 0 to 30 degrees Celsius (32 to 86 degrees Fahrenheit).
- Rechargeable lithium-ion battery will gradually lose its capacity over time resulting in decreased operation time for the product.
- Typical estimated life time of a lithium-ion battery is about three years or 500 cycles of full discharge whichever happens first.
- Do not leave the battery unused for extended periods of time. Charge the battery every 6 months. It is advisable to charge the battery to approximately 50% prior storage.
- To dispose of an old battery send the product back to the manufacturer or consult your local waste management professional.
- Never throw away the battery or the product to a regular garbage container. Always use the specialized waste containers for electronics or batteries.

8 Certification

The Catchbox Plus wireless system consists of:

- Catchbox Plus Transmitter (Model #: CBPLTX001)
- Catchbox Plus Receiver (Model #: CBPLRX001)
- Catchbox Wireless Charger (Model #: CBWCH0002)
- Presenter Mic (Model #: CBPRTX001)



Catchbox Plus Transmitter

(Model #: CBPLTX001)

Catchbox Plus Receiver

(Model #: CBPLRX001)

Presenter Mic

(Model #: CBPRTX001)

All 3 products contain a pre-certified DECT module and meets the essential requirements of the European RED directive 2014/53/EU and is found to comply with the following standards:

EN 301 406 V2.2.2

EN 303 417 V1.1.1

EN 55032:2015 & EN 55035:2017

EN 301 489-3 V2.1.1 & ETSI EN 301 489-6 V2.2.0 (ETSI EN 301 489-1 V2.1.1)

Certified under FCC CFR 47 Part 15 Subpart D.

FCC ID: Y82-SC14S

Certified under IC in Canada under ISED RSS-213 Issue 3, ISED RSS-GEN Issue 4.

IC: 9576S-SC14S

Complies with
IMDA Standards
DA105282

Catchbox Wireless Charger

(Model #: CBWCH0002)

Product meets the essential requirements of the European RED directive 2014/53/EU and is found to comply with the following standards:

EN 301 406 V2.2.2

EN 303 417 V1.1.1

EN 55032:2015 & EN 55035:2017

EN 301 489-3 V2.1.1

Certified under FCC CFR 47 Part 15 Subpart D.

FCC ID: 2AP8UCBWCH0001

Certified under IC in Canada under ISED RSS-213 Issue 3, ISED RSS-GEN Issue 4.

IC: 11942A-CBWCH0001

Complies with
IMDA Standards
DA105282



www.catchbox.com

